



IDW-90

ISDN Terminaladapter



General information

Legal information

The contents of this document are provided “as is”. Except as required by applicable law, no warranties of any kind, either express or implied, including, but not limited to, the implied warranties of merchantability and fitness for a particular purpose, are made in relation to the accuracy and reliability or contents of this document. Westermo reserves the right to revise this document or withdraw it at any time without prior notice.

Under no circumstances shall Westermo be responsible for any loss of data or income or any special, incidental, and consequential or indirect damages howsoever caused.

More information about Westermo can be found at the following Internet address:
www.westermo.com

Safety



Before installation:

Read this manual completely and gather all information on the unit. Make sure that you understand it fully. Check that your application does not exceed the safe operating specifications for this unit.

This unit should only be installed by qualified personnel.

This unit should be built-in to an apparatus cabinet, or similar, where access is restricted to service personnel only.

The power supply wiring must be sufficiently fused, and if necessary it must be possible to disconnect manually from the power supply. Ensure compliance to national installation regulations.

This unit uses convection cooling. To avoid obstructing the airflow around the unit, follow the spacing recommendations (see Cooling section).



Before mounting, using or removing this unit:

Prevent access to hazardous voltage by disconnecting the unit from power supply. Warning! Do not open connected unit. Hazardous voltage may occur within this unit when connected to power supply.

Care recommendations

Follow the care recommendations below to maintain full operation of unit and to fulfil the warranty obligations.

This unit must not be operating with removed covers or lids.

Do not attempt to disassemble the unit. There are no user serviceable parts inside.

Do not drop, knock or shake the unit, rough handling above the specification may cause damage to internal circuit boards.

Do not use harsh chemicals, cleaning solvents or strong detergents to clean the unit.

Do not paint the unit. Paint can clog the unit and prevent proper operation.

Do not expose the unit to any kind of liquids (rain, beverages, etc). The unit is not waterproof. Keep the unit within the specified humidity levels.

Do not use or store the unit in dusty, dirty areas, connectors as well as other mechanical part may be damaged.

If the unit is not working properly, contact the place of purchase, nearest Westermo distributor office or Westermo Tech support.

Fibre connectors are supplied with plugs to avoid contamination inside the optical port.

As long as no optical fibre is mounted on the connector, e.g. for storage, service or transportation, should the plug be applied.

Maintenance

No maintenance is required, as long as the unit is used as intended within the specified conditions.

Product disposal.



This symbol means that the product shall not be treated as unsorted municipal waste when disposing of it. It needs to be handed over to an applicable collection point for recycling electrical and electronic equipment.

By ensuring this product is disposed of correctly, you will help to reduce hazardous substances and prevent potential negative consequences to both environment and human health, which could be caused by inappropriate disposal.

Simplified EU declaration of conformity

Hereby, Westermo declares that the equipment is in compliance with applicable EU directives. The full EU declaration of conformity and other detailed information are available at the respective product page at www.westermo.com.

Agency approvals and standards compliance

Type	Approval / Compliance
EMC	EN 61000-6-1, Immunity residential environments
	EN 61000-6-2, Immunity industrial environments
	EN 61000-6-3, Emission residential environments
	EN 61000-6-4, Emission industrial environments
	EN 50121-4, Railway signalling and telecommunications apparatus
	IEC 62236-4, Railway signalling and telecommunications apparatus
Safety	EN 60950-1, IT equipment
ISDN	TBR-3

FCC Part 15.105 Notice:

This equipment has been tested and found to comply with the limits for a Class B digital device, pursuant to Part 15 of the FCC Rules. These limits are designed to provide reasonable protection against harmful interference in a residential installation. This equipment generates, uses and can radiate radio frequency energy and, if not installed and used in accordance with the instructions, may cause harmful interference to radio communications. However, there is no guarantee that interference will not occur in a particular installation. If this equipment does cause harmful interference to radio or television reception, which can be determined by turning the equipment off and on, the user is encouraged to try to correct the interference by one or more of the following measures:

- ⌘ Reorient or relocate the receiving antenna
- ⌘ Increase the separation between the equipment and receiver
- ⌘ Connect the equipment into an outlet on a circuit different from that to which the receiver is connected
- ⌘ Consult the dealer or an experienced radio/TV technician for help.

Type tests and environmental conditions

Electromagnetic Compatibility			
Phenomena	Test	Description	Test levels
ESD	EN 61000-4-2	Enclosure contact	± 6 kV
		Enclosure air	± 8 kV
RF field AM modulated	IEC 61000-4-3	Enclosure	10 V/m 80% AM (1 kHz), 80 – 1 000 MHz 20 V/m 80% AM (1 kHz), 80 – 2 000 MHz
RF field 900 MHz	ENV 50204	Enclosure	20 V/m pulse modulated 200 Hz, 900 ± 5 MHz
Fast transient	EN 61000-4-4	Signal ports	± 2 kV
		Power ports	± 2 kV
Surge	EN 61000-4-5	Signal ports unbalanced	± 2 kV line to earth, ± 2 kV line to line
		Signal ports balanced	± 2 kV line to earth, ± 1 kV line to line
		Power ports	± 2 kV line to earth, ± 2 kV line to line
RF conducted	EN 61000-4-6	Signal ports	10 V 80% AM (1 kHz), 0.15 – 80 MHz
		Power ports	10 V 80% AM (1 kHz), 0.15 – 80 MHz
Power frequency magnetic field	EN 61000-4-8	Enclosure	100 A/m, 50 Hz, 16.7 Hz & 0 Hz
Pulse magnetic field	EN 61000-4-9	Enclosure	300 A/m, 6.4 / 16 ms pulse
Mains freq. 50 Hz	EN 61000-4-16	Signal ports	100 V 50 Hz line to earth
Mains freq. 50 Hz	SS 436 15 03	Signal ports	250 V 50 Hz line to line
Voltage dips and interruption	EN 61000-4-29	DC power ports	10 & 100 ms, interruption 10 ms, 30% reduction 10 ms, 60% reduction+20% above & -20% below rated voltage
Radiated emission	EN 55022	Enclosure	Class B
	FCC part 15		Class B
Conducted emission	EN 55022	DC power ports	Class B
Dielectric strength	EN 60950	Signal port to other isolated ports	2 kVrms 50 Hz 1 min
		Power port to other isolated ports	3 kVrms 50 Hz 1 min 2 kVrms 50 Hz 1 min (@ rated power <60 V)
Environmental			
Temperature		Operating	+5 to +55°C /
		Storage & Transport	-25 to +70°C
Humidity		Operating	5 to 95% relative humidity
		Storage & Transport	5 to 95% relative humidity
Altitude		Operating	2 000 m / 70 kPa
Reliability prediction (MTBF)	MIL-HDBK- 217F	Operating	
Service life		Operating	10 year
Vibration	IEC 60068-2-6	Operating	7.5 mm, 5 – 8 Hz 2 g, 8 – 500 Hz
Shock	IEC 60068-2-27	Operating	15 g, 11 ms
Packaging			
Phenomena	Test	Description	Level
Enclosure	UL 94	PC / ABS	Flammability class V-1
Dimension W x H x D			35 x 121 x 119 mm
Weight			0.25 kg
Degree of protection	IEC 529	Enclosure	IP 21
Cooling			Convection
Mounting			Horizontal on 35 mm DIN-rail

Description

The Westermo IDW-90 is an industrialised ISDN Terminal adapter. This Terminal adapter has been developed with high speed industrial data communications in mind and has some features you would not expect to find on normal adapters.

The unit is DIN rail mounted and has both an RS-232/V.24 and RS-485 interface supporting both 2 and 4 wire connections.

Terminal data rates of up to 230 kbit/sec can be handled with a 128 kbit/s ISDN B-channel bit rate.

The IDW-90 has been designed to meet the European ISDN standard DSS1. All standard ISDN transport protocols are supported including HDLC transparent, V.110 asynchronous, X.75, PPP and ML-PPP.

In the IDW-90 has also an analogue V.34 modem been included allowing communication with analogue modems over the ISDN. The IDW-90 can be configured to automatically select if analogue modem shall be used to reach the called location.

The combination of analogue and ISDN modem and V.110 protocol support makes the IDW 90 especially suited for mixed environments there an ISDN connected modem shall be reached from ISDN, analogue and GSM networks .

A watchdog facility continually monitors the power supply and internal hardware as well as the operational software. In the event of a problem the modem automatically resets. This feature has been included to make the unit more suitable for use in unmanned locations.

The modem also has password protection, dial-back security and caller ID answering to ensure that only authorised users can communicate with the modem and any connected equipment.

The IDW-90 also has a single digital input and output relay. The input and output can be used to trigger, or be triggered by a number of different user defined events. Both the digital input and output are galvanically isolated from the rest of the modem.

For ease of setup the modem is supported by the Westermo IDW-tool configuration software but also has DIP switches to assist configuration. Drivers for Windows setup are also supplied.

- ⌘ Connection to analogue telephone modems
- ⌘ DTE data rate up to 230 kbit/s
- ⌘ ISDN data rate up to 128 kbit/s (ISDN)
- ⌘ Analogue data rate up to 33.6 kbit/s (V.34)
- ⌘ ISDN leased line support
- ⌘ Generic I/O inputs
- ⌘ Generic Relay output
- ⌘ DTR/TX and I/O event triggered dialling
- ⌘ Secure connection and dial-back
- ⌘ Remote configuration
- ⌘ Configuration by DIP-switches
- ⌘ Event triggered SMS-message transmission.
- ⌘ Industrial and railway level of protection
- ⌘ Polarity independent AC-/DC-supply
- ⌘ Galvanic isolation (Power supply – ISDN – I/O – Serial interfaces)
- ⌘ Built in watchdog

Functional description

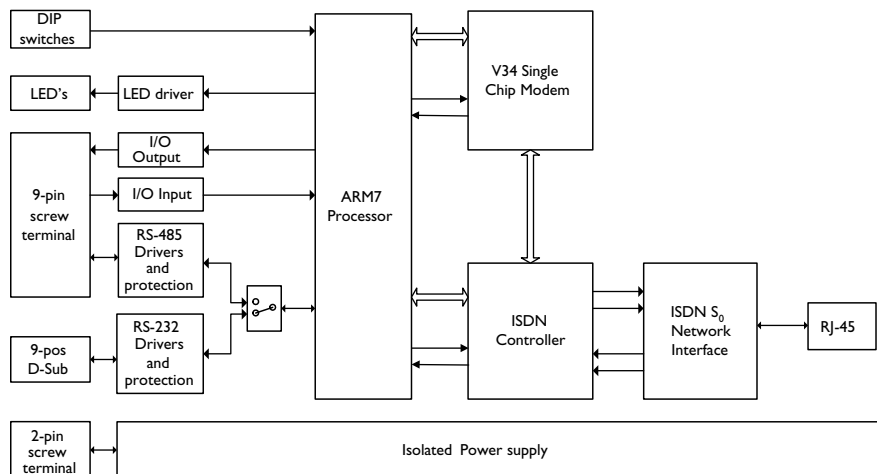

Remote configuration

The IDW-90 can be configured from a remote modem. To configure a IDW-90 any GSM , ISDN or PSTN modem can be used.

The modem used to configure is referred as “local modem”. Enable remote config by setting DIP switch 4:7.

Please make sure that the remote IDW-90 is connected to the ISDN network and is powered up.

- ⌘ Connect the local modem to it’s media (ISDN, PSTN or GSM)
 - ⌘ Connect the PC’s com-port to the DTE interface of the local modem.
 - ⌘ Connect the power supply.
 - ⌘ Start a terminal emulation program (i.e.Windows Hyper-Terminal)
 - ⌘ Configure the local modem protocol
1. If local modem is a GDW-11/12 a normal GSM data connection should be used.
 2. If local connection is ISDN, configure with the B channel protocol V110 9600 bit/s
 3. If local connection uses some analogue modem, the modem has to be configured for V32 modulation line speed 9600 bit/s.
- ⌘ Set up a connection to the remote IDW-90 to be configured by using the normal dial command: `ATD<No><CR>`. When connected send the remote escape sequence `<++++>`. The called remote IDW-90 shall acknowledges by requesting the remote password. Please enter the correct password (default: no password, just return). Now you can configure the remote IDW-90 using AT-commands. Password for remote configuration is defined with `AT*WRAP` – Remote access password.
 - ⌘ Configure the parameter on the remote IDW-90 from your terminal program and save the settings with `AT&W`.

Hang up the connection using the ATH command.

Generic I/O

The generic I/O gives the following functionality:

- 1. Establishing a data connection to a predefined target number**

When the input is switched (pulsed), the modem establish a data connection to the stored predefined number. After a time, specified in the modem, without data exchange, the connection is released (inactivity timer).
- 2. Sending a SMS Message to a predefined targetnumber**

When the input is switched (pulsed), the modem shall establish a connection to a SMS service centre defined by a predefined number. The SMS Messages can handle at least 160 characters. TAP and UCP protocols are supported.
- 3. Sending a Text Message to a predefined targetnumber**

When the input is triggered, the modem will establish a connection to the stored telephone number and transfer a predefined text message.
- 4. Switch the remote digital output**

When the input is triggered, the modem will establish a connection to the stored number of an remote unit and send out a command, that switches (pulses) the remote output according to a predefined sequence.
- 5. Execute AT-Command string**

Execute a pre-programmable AT command string stored in the table of entries. This can for example be used for switching DTE communication parameters for online an offline mode by using two entries.
- 6. Transparent I/O**

When the input is triggered, the modem will establish a connection to the stored number of an remote unit and send out a command, after a connection is established, the I/O is bi-directional.
To accept any remote generic I/O on a modem the "Remote I/O Enable" DIP switch must be set "ON"

Digital Output

The digital output gives the following functionality:

- 1. Output Contact**

The modem has an change over relay output (SPDT-contact). The output can be controlled by a remote modem through Transparent I/O and Output service in the Generic I/O function. The output can also be programmed to follow the local DCD or DTR signals.
- 2. Remote controlled**

The output can be programmed to follow a remote modem data input. A remote unit can also set/reset the output as well as transferring a sequence of set- and resets of the output.
- 3. Follow DCD/Network**

The output can be programmable to follow the local DCD or DTR signal.

Digital Input

The digital input gives the following functionality:

1. Static input

A static digital level triggered input high or low triggers the Generic I/O. With a level triggered input only the first entry in the Generic I/O list can be triggered by the I/O input.

The input is triggered when the selected level has been stable for t_a ms.

A new trig will not occur until the input has returned to the opposite state and back again.

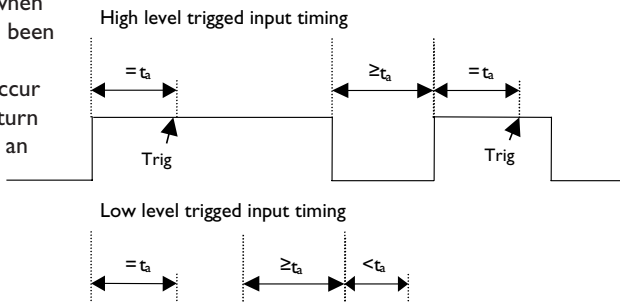

2. Pulsed Input

When input is set to edge triggered pulsed the number of pulses counted selects the entry to be triggered.

For the pulsing of an input, some timings must be kept.

The input is filtered and pulses shorter than t_a is discriminated. The time between pulses must also be kept shorter than T_p . One other restriction on T_p is that $T_p \geq 2t_a$. When time between pulses exceeds T_p the number of pulses are accumulated and an entry selected by number of pulses counted.

The parameter t_a is also used when output pulsing is selected.

The parameters t_a and t_p are programmable from 10 ms to 2550 ms.

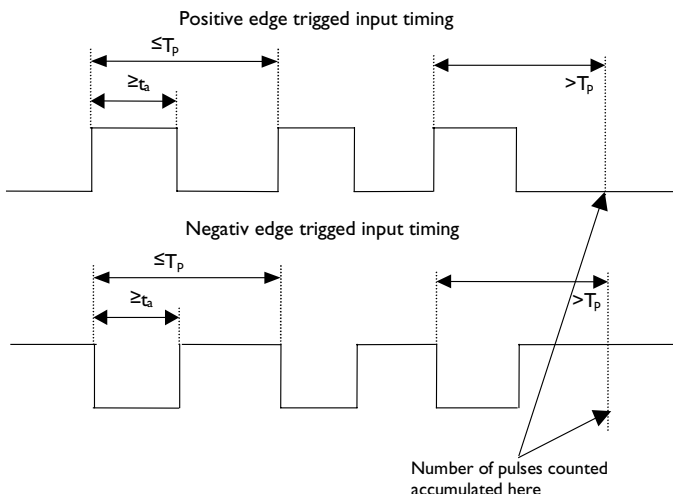

Interface specifications

Power “LV”	
Rated voltage	12 to 48 VDC 12 to 34 VAC
Operating voltage	10 to 60 VDC 10 to 42 VAC
Rated current	110 mA @ 12 VDC 55 mA @ 24 VDC 30 mA @ 48 VDC
Rated frequency	DC / AC 48 – 62 Hz
Inrush current I ² t	0.22 A ² s
Startup current*	0.30 A _{peak}
Polarity	Polarity independent
Isolation to	All other ports 3 kV _{rms} 50 Hz 1 min
Connection	Detachable screw terminal
Connector size	0.2 – 2.5 mm ² (AWG 24 – 12)
Shielded cable	Not required

* External supply current required for proper startup.

Integrated Services Digital Network (ISDN)	
Electrical specification	ISDN BRI: ITU-T I.430.
Data rate	300 bit/s – 128 kbit/s
Protocol	Euro ISDN /DSS1, Leased line B1 / B2 V.110 asynchronous, HDLC async to sync, HDLC transparent, Byte transparent X.75- SLP, V.120, X.31 B channel, X.31 D channel, ML-PPP
Protection	Installation Fault Tolerant (up to ±60 V)
Isolation to	Power port 3 kV _{rms} 50 Hz 1 min RS-232 2 kV _{rms} 50 Hz 1 min RS-485 2 kV _{rms} 50 Hz 1 min I/O 2 kV _{rms} 50 Hz 1 min
Connection	RJ-45
Shielded cable	Not required

RS-422/485	
Electrical specification	EIA RS-485 2-wire or 4-wire twisted pair
Data rate	300 bit/s – 115.2 kbit/s
Data format	7 or 8 data bits, Odd, even or none parity, 1 or 2 stop bits, Σ 9 – 12 bits
Protocol	Transparent
Retiming	Yes
Turn around time	50 μ s (half duplex)
Transmission range	<1200 m, depending on data rate and cable type (EIA RS-485)
Settings	120 Ω termination and failsafe biasing 680 Ω
Protection	Installation Fault Tolerant (up to \pm 60 V)
Isolation to	Power port 3 kV _{rms} 50 Hz 1 min ISDN 2 kV _{rms} 50 Hz 1 min IO 2 kV _{rms} 50 Hz 1 min
Galvanic connection to	RS-232
Connection	Detachable screw terminal
Connector size	0.2 – 2.5 mm ² (AWG 24 – 12)
Shielded cable	Not required*
Miscellaneous	Do not connect RS-232 and RS-422/485 simultaneously

* To minimise the risk of interference, a shielded cable is recommended when the cable is located inside 3 m boundary to the rails and connected to this port.
The cable shield should be properly connected (360°) to an earthing point within 1 m from this port. This earthing point should have a low impedance connection to the conductive enclosure of the apparatus cabinet, or similar, where the unit is built-in. This conductive enclosure should be connected to the earthing system of an installation and may be directly connected to the protective earth.

RS-232	
Electrical specification	EIA/TIA-232
Data rate	1 200 bit/s – 115.2 kbit/s
Data format	7 or 8 data bits, Odd, even or none parity, 1 or 2 stop bits; Σ 9 – 12 bits
Protocol	Transparent
Retiming	Yes
Transmission range	Cable length \leq 15 m
Isolation to	Power port 3 kV _{rms} 50 Hz 1 min ISDN line 2 kV _{rms} 50 Hz 1 min I/O 1.5 kV _{rms} 50 Hz 1 min
Galvanic connection to	RS-485
Connection	9-pin D-sub female (DCE)
Shielded cable	Not required*
Miscellaneous	Do not connect RS-232 and RS-422/485 simultaneously

Generic I/O Input	
Electrical specification	Opto isolated input
Input voltage range	0 – 60 VDC
Input current	5mA @ 60VDC
Input inactive	U _{in} <2.5 V
Input active	U _{in} >5.0 V
Transmission range	Cable Length \leq 15 m
Connection	Detachable screw terminal (DCE)
Connector size	0.2 – 2.5 mm ² (AWG 24 – 12)
Isolation to	Power port 3 kV _{rms} 50 Hz 1 min ISDN line 2 kV _{rms} 50 Hz 1 min RS-232 2 kV _{rms} 50 Hz 1 min RS-485 2 kV _{rms} 50 Hz 1 min I/O output 2 kV _{rms} 50 Hz 1 min
Shielded cable	Not required*

* To minimise the risk of interference, a shielded cable is recommended when the cable is located inside 3 m boundary to the rails and connected to this port.

The cable shield should be properly connected (360°) to an earthing point within 1 m from this port.

This earthing point should have a low impedance connection to the conductive enclosure of the apparatus cabinet, or similar, where the unit is built-in. This conductive enclosure should be connected to the earthing system of an installation and may be directly connected to the protective earth.

Generic I/O Relay Output	
Electrical specification	One change over contact
Switching voltage	Max 40 VAC/DC
Switching current	Max 500 mA AC/DC
Electrical endurance	5 x 10 ⁵ operations @ 20 W / 20 VA Resistive load
Transmission range	Cable Length ≤15 m
Connection	Detachable screw terminal (DCE)
Connector size	0.2 – 2.5 mm ² (AWG 24 – 12)
Isolation to	Power port 3 kV _{rms} 50 Hz 1 min ISDN line 2 kV _{rms} 50 Hz 1 min RS-232 1.5 kV _{rms} 50 Hz 1 min RS-485 1.5 kV _{rms} 50 Hz 1 min I/O input 2 kV _{rms} 50 Hz 1 min
Shielded cable	Not required*

* To minimise the risk of interference, a shielded cable is recommended when the cable is located inside 3 m boundary to the rails and connected to this port.

The cable shield should be properly connected (360°) to an earthing point within 1 m from this port.

This earthing point should have a low impedance connection to the conductive enclosure of the apparatus cabinet, or similar, where the unit is built-in. This conductive enclosure should be connected to the earthing system of an installation and may be directly connected to the protective earth.

Connections

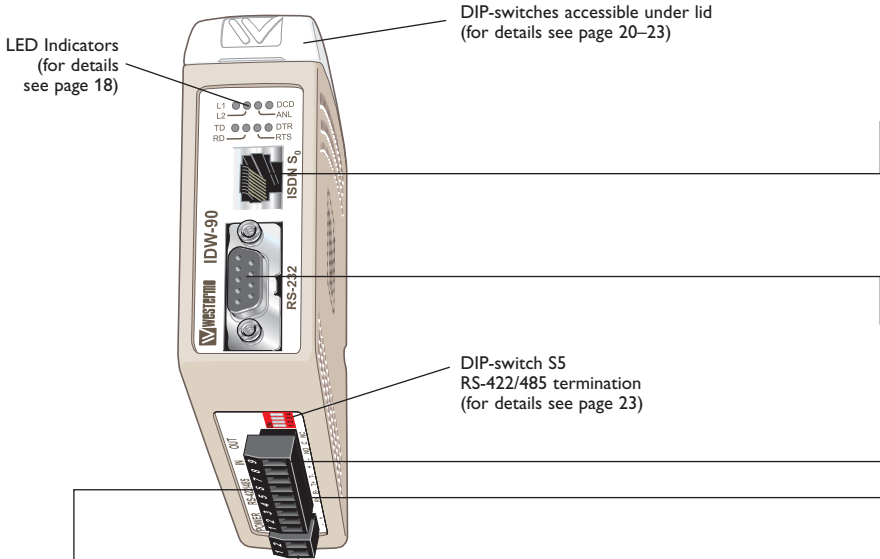

Position	Direction*	Description	Product marking
1	In	AC: Neutral DC: – Voltage	COM
2	In	AC: Line DC: + Voltage	+VA

Position	Direction*	Description	Product marking
No 1	In	R+ (A') Receive	RS-422/485 4-wire R+
No 2	In	R– (B') Receive	RS-422/485 4-wire R–
No 3	In/Out	T+ (A) Transmit	RS-422/485 4-wire
	Out	T+ (A/A') Transmit/Receive	RS-485 2-wire T/R+
No 4	Out	T– (B) Transmit	RS-422/485 4-wire
	In/Out	T+ (A/A') Transmit/Receive	RS-485 2-wire T/R–

Position	Direction*	Description
1	–	NC
2	–	NC
3	Out	Transmit +
4	In	Receive +
5	In	Receive –
6	Out	Transmit –
7	–	NC
8	–	NC

Position	Direction*	Description
No 1	Out	Data Carrier Detect (DCD)
No 2	Out	Received Data (RD)
No 3	In	Transmitted Data (TD)
No 4	In	Data Terminal Ready (DTR)
No 5	–	Signal Ground (SG)
No 6	Out	Data Set Ready (DSR)
No 7	In	Request To Send (RTS)
No 8	Out	Clear To Send (CTS)
No 9	Out	Ring Indicator (RI)

Position	Direction*	Description	Product marking
No 7	In/Out	Normal closed contact	NC
No 8	In/Out	Common contact	C
No 9	In/Out	Normal open contact	NO

Position	Direction*	Description	Product marking
No 5	In	Input +	+
No 6	In	Input –	–

LED indicators



LED	Status	Description
L1 ISDN Line status	See below	LED normally showing the status of the ISDN S ₀ interface. L1 together with L2 is also used to indicate error conditions in the IDW-90 and the connection to the ISDN S ₀ interface.
L2 ISDN Data connection	See below	LED Normally showing the state of the data connection
ANL Analogue line	OFF	No analogue connection established
	BLINK	Analogue call in progress
	ON	Analogue line established
DCD Data Carrier Detect	OFF	The DCD signal is inactive.
	ON	The DCD signal is active. The behavior of the DCD-line is programable, see configuration command <code>cdcd</code> . Normally used to indicate an active connection
TD Transmit Data		LED showing data from the DTE, the LED will blink when data received
RD Receive Data		LED showing data transmitted to the DTE, the LED will blink when data transmitted
RTS Request to Send	OFF	RTS signal is inactive used for flow control this indicates DTE not ready to receive
	ON	RTS signal is active used for flow control this indicates DTE ready to receive
DTR Data Terminal Ready	OFF	DTR Signal from DTE is inactive
	ON	DTR Signal from DTE is active The use of the DTR signal is programmable, see configuration command <code>cdtr</code>

Status		Description
L1	L2	
ON	OFF	S ₀ connection OK
ON	1 short blink/s	Call setup in progress
ON	1 long blink/s	Waiting for B channel synchronization
ON	ON	Data connection is established
OFF	OFF	No power or Hardware error
0.5 s ON 0.5 s OFF	OFF	No S ₀ connection

Configuration

All needed configurations and parameter settings are done by the DIP-switches, located under the top lid of the IDW-90.

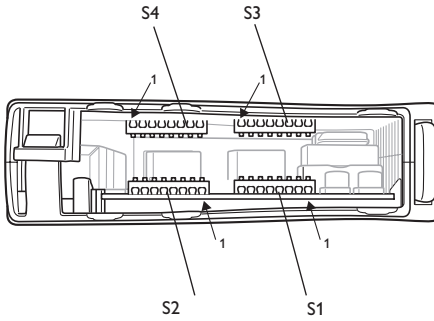

DIP-switch settings

Before DIP-switch settings:

Prevent damage to internal electronics from electrostatic discharges (ESD) by discharging your body to a grounding point (e.g. use of wrist strap)

NOTE DIP-switch alterations are only effective after a power on or commands “AT*loadsw” and “AT*reset”.

A setting configured by any other method during normal operation, overrides the DIP-switch setting. However, at power up, the DIP-switch settings have precedence over the setting configured by any other method.

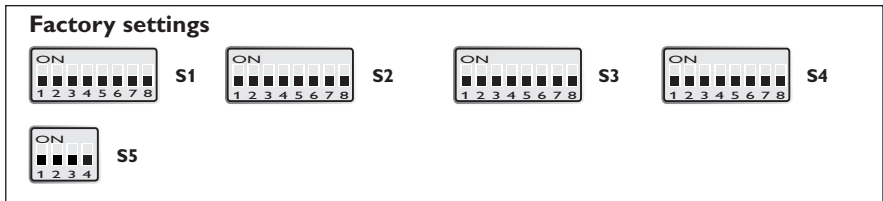

S1 DIP-switch Selection of DTE speed



Auto Baud



300 bit/s



600 bit/s

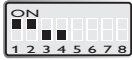

1200 bit/s

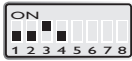

2400 bit/s

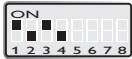

4800 bit/s



9600 bit/s



19.2 kbit/s

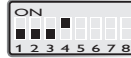

38.4 kbit/s



57.6 kbit/s



115.2 kbit/s

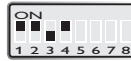

230 kbit/s

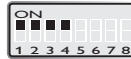

Use stored values

S1 DIP-switch Selection of DTE format



Use stored values



7E 1S



7O 1S



8N 1S



8E 1S



8O 1S



7E 2S



7O 2S



8N 2S



8E 2S



8O 2S

S2 DIP-switch DTE flow control



Use stored values



Hardware flow control
RTS/CTS AT&K3



No flow control CTS is always ON,
RTS ignored AT&K0&R1

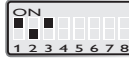

Software flow control
XON/XOFF
CTS is always ON, RTS
ignored AT&K4&R1



No flow control CTS follows DTR,
RTS ignored AT&K0 &R2

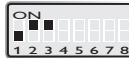

Software flow control
XON/XOFF CTS fol-
lows DTR, RTS ignored
AT&K4&R2



No flow control CTS follows changes
on RTS AT&K0&R0



Software flow control
XON/XOFF
CTS follows
RTS AT&K4

S2 DIP-switch DTR handling



Use stored values



DTR is evaluated:
Dropping the DTR line
by the DTE will discon-
nect an existing ISDN
connection. An incoming
call will be accepted
only with DTR active.
AT&D2 or AT**cdtr = 2



DTR is evaluated:
Ignored. AT&D or AT**cdtr = 0



DTR is evaluated:
Incoming calls will be
accepted independent of
DTR status; DTR drop
disconnects an active
connection. AT&D4 or
AT**cdtr = 4

S2 DIP-switch RS-485 control



RS-232 enable
RS-422/485 disable



RS-422/485 4 wire
enable RS-232 disable



RS-485 2 wire enable
RS-232 disable

S2: 8 not used

S3 DIP-switch B-channel protocol



Use stored values

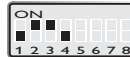

X.75-NL



V.110 asynchronous

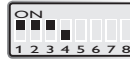

7 V.120 asynchronous
O 2S

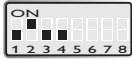

V.110 configured for GSM

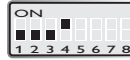

X.25 / X.31 B channel
(X.25 B channel)



HDLC asynchronous to synchronous
conversion (for PPP asynchronous and
single link PPP)



X.25 / X.31 D channel



HDLC transparent (DTE data octets
packed into HDLC frames)



ML-PPP Multilink PPP



Byte transparent (raw B-channel data)

S3 DIP-switch Command interface



Use stored values



Hot line TxD call



AT-command set



Connect always



Hot line DTR call

S3: 8 not used

S4 DIP-switch D-channel protocol



Use stored values

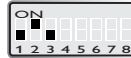

Leased line using channel
B1 AT**isdn=12



ISDN D-channel protocol
DSS1 AT**isdn=0



Leased line using channel
B2 AT**isdn=13

S4 DIP-switch Local echo



Use stored values

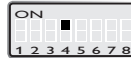

Disable Local echo, ATE0

S4 DIP-switch Result code handling



Use stored values



Numeric result codes,
ATV0



Suppress result codes,
quiet mode, ATQ1

S4 DIP-switch D-channel protocol



Use stored values



Enable remote
configuration

S4 DIP-switch D-channel protocol



Use stored values



Disable automatic
selection between
ISDN and PSTN

S5 DIP-switch Termination



No termination



Termination of R in 4-wire connection



Termination of both T and R
in 2-wire connection



Termination of both T and R in 4-wire connection

RS-422/485 general advice

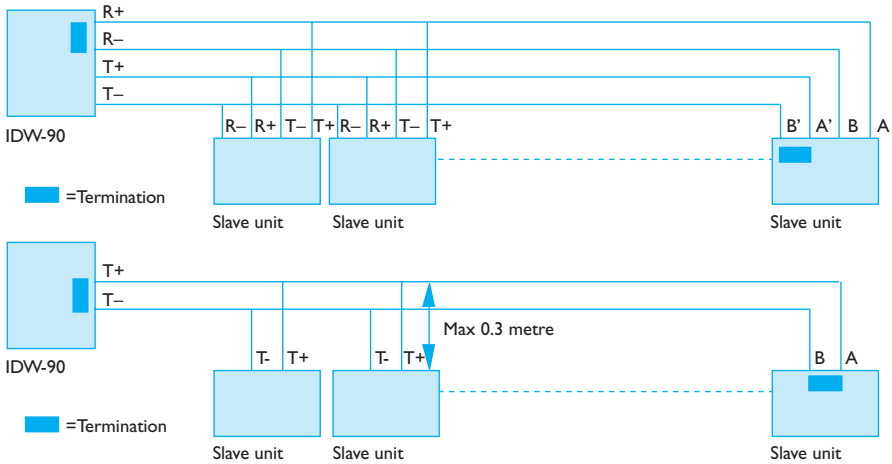

Termination recommendations

The RS-422/485 line must be terminated. In the TD-36 485, the termination is combined with fail-safe functionality. The termination is used to prevent undefined states when the bus is in tri-state condition.

- ⚡ Using 2-wire RS-485 both ends should be terminated.
- ⚡ Using 4-wire RS-485 both pairs shall be terminated at both ends.
- ⚡ Using 4-wire RS-422 it's only necessary to terminate the receivers.

RS-422/485 connection pins can be differently named. For some equipment brands the T+ corresponds to A, but other brands might use some other naming convention. If a unit does not work it can help to swap A and B.

Mounting

This unit should be mounted on 35 mm DIN-rail, which is horizontally mounted inside an apparatus cabinet, or similar. Snap on mounting, see figure.

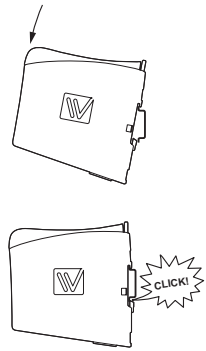

Cooling

This unit uses convection cooling. To avoid obstructing the air-flow around the unit, use the following spacing rules. Minimum spacing 25 mm (1.0 inch) above /below and 10 mm (0.4 inches) left /right the unit. Spacing is recommended for the use of unit in full operating temperature range and service life.

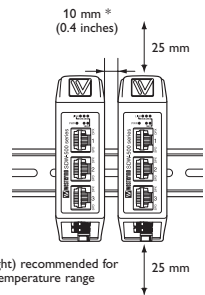

Removal

Press down the black support at the top of the unit. See figure.

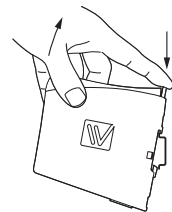

Windows configuration tool ID-Tool

The ID-Tool is a PC – application program with a graphical interface for easy configuration of the complex functions found in the IDW-90.

Please refer to ID-Tool for a complete description of the functionality of the Windows program.

Configuration

The IDW-90 can be configured both from the local DTE interface and remotely over the ISDN network. Independently if the local or remote interface is used the configuration can be made with AT-commands or with a PC-based application configuration tool. Basic configurations can also be made with DIP-switches locally.

AT-Commands

The most commonly used commands are listed below in short format

Please refer to the document "IDW-90 AT-Command Guide" for a complete list of all the available AT-commands and a detailed description of the serial AT-command interface.

A – Answer a call

Syntax: ATA

****br – Fixed DTE rate**

Syntax:

AT**br=<n>

AT**br=?

AT**br

Parameters:

<n>:

- 0: Autobauding, (automatic local bit rate adaption) (default)
- 1: 1 200 bit/s
- 2: 2 400 bit/s
- 3: 4 800 bit/s
- 4: 9 600 bit/s
- 5: 19 200 bit/s
- 6: 38 400 bit/s
- 7: 57 600 bit/s
- 8: 115 200 bit/s
- 9: 230 400 bit/s
- 20: 300 bit/s
- 21: 600 bit/s

&C –DCD Option

Syntax:

AT&C<n>

Parameters:

<n>

- 0: DCD always ON
- 1: DCD indicates a connection (default)
- 2 DCD follows DTR
- 3: DCD indicates link level established (X.31-D only)

****cmds – Command set**

Syntax:

AT**cmds=<n>

Parameters:

<n>

- 0: AT command set (default)
- 6: Automatic dialling when DTR is set
- 7: Automatic dialling when TxD is received by the IDW-90
- 8: Automatic dialling always connect
- 10: IDW-90+Configurator
- 12: Incoming calls only

D and DL – Dial command

Syntax:

ATD<nb> where <nb> represents a dial string composed of dial characters and dial modifiers.

&D – DTR Control

Syntax:

AT&D<n>

Parameters:

<n>

- 0: The DTR signal is ignored (Default)
- 2: Upon DTR switch from ON to OFF, the call is hang up. DTR need to be high to accept incoming calls. (Default)
- 4: Upon DTR switch from ON to OFF, the call is hang up DTR doesn't affect incoming calls accepted .

****dabort – Dial abort**

Syntax:

AT**dabort=<n>

Parameters:

<n>

- 0: Dialling will not be aborted by incoming characters.
- 1: Characters from DTE aborts dial during the connection process (default).

****dbits – Asynchronous databits**

Syntax:

AT**dbits=<n>

AT**dbits=?

AT**dbits

Parameters:

<n>:

- 7: Set format to 7 databits
- 8: Set format to 8 databits

E – Echo

Syntax:

ATE<n>

Parameters:

<n>

- 0: Characters are not echoed
- 1: Characters are echoed

&F – Restore Factory Configuration

Syntax:

AT&F<n>

Parameters:

<n>

- 0: Setup all parameter concerning data port.
- 1: Setup all parameter including ISDN protocol and msn settings.

H – Disconnect (Hang-Up)

Syntax:

ATH<n>

Parameters:

<n>

- 0: The modem will release the line if the modem currently is on-line.
- 1: If on-hook, the modem will go off-hook and enter command mode.

&K – DTE-DCE flow control

Syntax:

AT&K<n>

Parameters:

<n>

- 0: Disables Flow Control (Default).
- 3: Enables RTS/CTS flow control in data mode.
- 4: Enables XON/XOFF.
- 5: Enables RTS/CTS flow control in data and command mode.

!+MS – Select Modulation for analogue connections

Syntax:

+MS=<carrier>,<automode>,<min_tx_rate>,<max_tx_rate>,<min_rx_rate>,<max_rx_rate>

+MS= ?

+MS ?

Parameters:

<carrier>

B103 300 bit/s

B212 1200 bit/s

V21 300 bit/s

V22 1200 bit/s

V22B 1200 or 2400 bit/s

V23C 1200 bit/s

V32 4800 or 9600 bit/s

V32B 4800, 7200, 9600, 12000 or 144400 bit/s

V34 2400, 4800, 7200, 9600, 12000, 14400, 16800, 19200, 21600, 24000, 26400, 28800, 31200, 33600, 33600 bit/s

<automode>

0: Disable

1: Enable

< min_xx_rate >, < max_xx_rate >

Minimum and maximum data rate depending on modulation used.

**prty – Asynchronous parity

Syntax:

AT**prty=<n>

AT**prty=?

AT**prty

Parameters:

<n>:

0: No parity

1: Set even parity

2: Set odd parity

Q – Result Code Control

Syntax:

ATQ<n>

Parameters:

<n>

- 0: DCE transmits result codes
- 1: Result codes are suppressed and not transmitted

S0 – Automatic answer

Syntax:

ATS0=<value>

Parameters:

<value>

- 0 Disable auto answer
- 1–255 Rings to answer on

V – Result format

Syntax:

ATV<n>

Parameters:

<n>

- 0 (Information responses): <text><CR><LF><CR><LF><numeric code><CR>
- 0 (Result codes): <numeric code><CR>
- 1 (Information responses): <CR><LF><text><CR><LF><verbose code><CR><LF>
- 1 (Result codes): <CR><LF><verbose code><CR><LF>

W – Connect message control

Syntax:

ATW<n>

Parameters:

<n>

- 0: Shows result code (RING, CONNECT) without additional info (default).
- 1: Result is presented with extended result codes. RING and CONNECT including ISDN address, all others include error causes. Message RINGING will be displayed with an outgoing call.

&W – Store system setting

Syntax:AT&W<n>

Parameters:<n>

- 0: Store the current configuration as profile 0
- 1: Store the current configuration as profile 1

⌘ IDW-90 connected to IDW-90 with DTR signal call



Configure the units

AT&F0	Set the unit to factory default
AT&F1	
AT&W	Store default settings

Set up the connection – The dialling modem

AT**catab1=nnn	Store the number of the remote modem in the automatic calling table of IDW-90
AT**cdsr=0	Set DSR signal always high (if this signal is used to trig the DTR)
AT**isdn=6	Activates automatic DTR dialling if DTR switches from low (OFF) to high (ON).
AT**save	Save settings
Switch DTR from OFF to ON	The modem will now dial the phone number stored in the first location of the automatic calling table

Set up the connection – The answering modem

ATA	Enter the answer command when RING comes from the network or set up ATSO=1 to auto answer on 1 RING signal (or more than 1).
-----	--

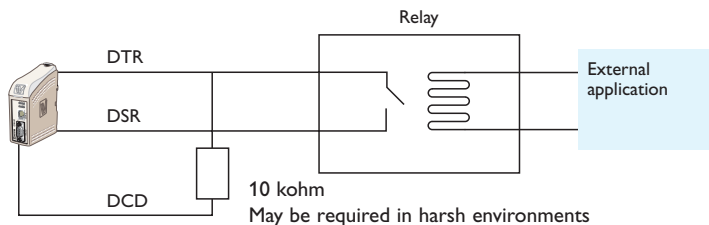

⌘ Frequently used settings for PLC-systems



Most PLC-systems and other industrial applications where modems are used, require the same changes to default settings.

The most commonly encountered problems concern speed, parity and control signals from the connected equipment.

Speed and parity are changed with the switches under the cover in block S1. If this action does not solve the problem the modem's answering codes and possible echoing of commands might be the source of the difficulty.

Below follows a list of commands that might resolve the problems. The commands may of course be placed on one single command line if desired.

Configure the IDW-90 connected to the PLC

AT&F0	Set the unit to factory default
ATV0	Gives the answering codes in short format. (digits)
ATQ1	No result codes are sent on the RS-232/V.24 connection.
ATE0	Commands that are sent from the terminal/computer etc. are not echoed back to the RS-232/V.24 connection.
AT&C1	DCD will follow the carrier on the line.
AT&K0	No handshaking.
at ^{!c} dabort=0	Character abort option OFF
AT&V	Save settings

⌘ Leased line connection



To set the adapter for leased line applications use the dipswitches.

Configure the units

at**defa=0	Set the unit to factory default
ATQ1	No result codes are sent on the RS-232/V.24 connection.
AT&W	Store default settings
S1	Set DTE speed and format
S4:1 ON or OFF S4:2 ON S4:3 OFF	Selects leased line, using channel B1 or B2
S3:1 OFF S3:2 OFF S3:3 ON S3:4 OFF	Sets B-channel protocol to HDLC transparent
S3:5 OFF S3:6 OFF S3:7 ON	Sets connections behaviour to Connect always

To make the setting active the power must be cycled OFF -> ON.

⌘ IDW-90 – Secure Call-back

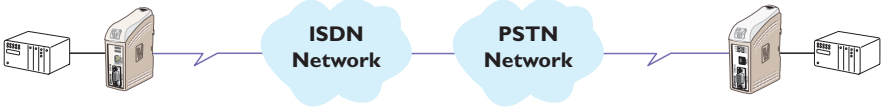

The IDW-90 is connected to a PLC which one want to restrict access to. The IDW-90 can support access control through the Secure Callback function. In this example password and callback to a predefined number is chosen. The modem in the calling end is here chosen to be a PSTN modem, but can be any of the PSTN, ISDN or GSM modem from the Westermo product range.

The DTE serial speed between the PLC – IDW-90 and TDW-33 – PC is assumed to be 9600 8N1 but can be chosen to fit the actual system requirement.

Configure the IDW-90

at:*defa=0 at:*defa=1	Set the unit to factory default
at:*br=4	DTE baudrate 9600
ATS0=1	Auto answer after first ring
ATQ1E0&C1&K0 at:*dabort=0	Suitable for PLC communication, see section Frequently used settings for PLC-systems
AT&W	Save settings
AT*WCB=4	Callback enabled, Password and callback number stored in one or more positions of wcbtab
AT*WCBTAB=1,"+4670428000","n3Y9kA6oYzu8"	Define callback number and password in position 1 When the password is entered number +4670428000 will be called.
AT*WCBTIME=10	Define delay time between hangup an callback The IDW-90 will wait 10 s after hangup to callback to allow the analogue modem to hangup

Configure the TDW-33

AT&F	Set the unit to factory default
AT+IPR=9600	DTE baudrate 9600
AT+ICF=3,4	Character framing 8 data, 1 stop, parity none
ATS0=1	Auto answer after first ring
AT&W	Store default settings

Set up the connection

The dialling modem TDW-33	The answering modem IDW-90	Comment
ATD0705123456	IDW-90 answers the call and requests the password from TDW-33	Dial the number to IDW-90
CONNECT 9600 Password: <i>n3Y9kA6otYZu8</i>	IDW-90 verifies the password to the passwords stored and if true compare disconnects.	Operator/system at TDW-33 enters Password: <i>n3Y9kA6otYZu8</i>
NO CARRIER	Wait 10 s	The connection is broken and TD-36 waits the programmed 10 s for TDW-33 to disconnect
CONNECT 9600	IDW-90 dials +4670428000	The number programmed corresponding to the password is dialled, preferable it's the number to the TDW-33
CONNECT 9600		Connection is established between the PC at TDW-33 and the PLC at IDW-90

⌘ IDW-90 sending text message with SMS by usage of Generic I/O

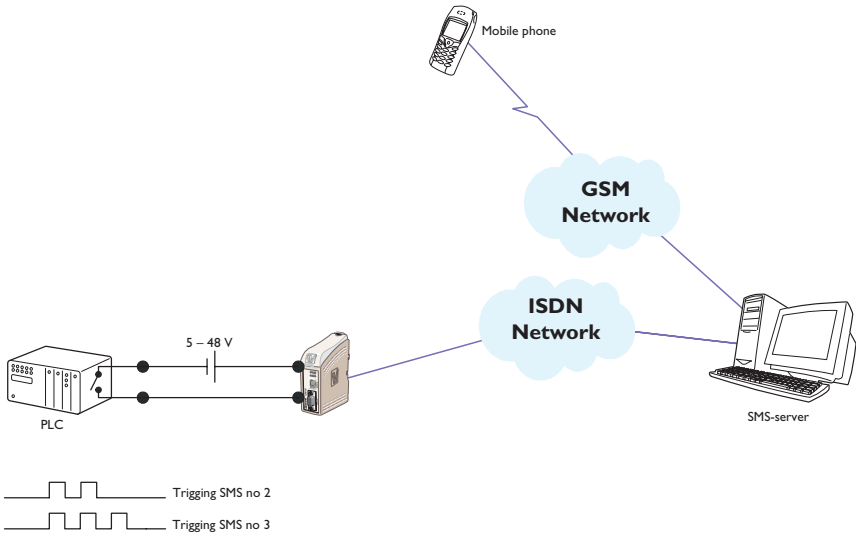



Configure a IDW-90 to send different SMS depending on the I/O input pulse train.

Configure the IDW-90

at**defa=0 at**defa=1	Set the unit to factory default
AT&W	Store default settings
AT*WIOp=5,10,2,3,0	Set I/O params Min pulse time = 50 ms (5) Max pulse time = 100 ms (10) Trig type = Pulsed triggered (2) Pulse trig type = POS, pos edge (3) Output type = No output (0)
AT*WIOl=2,2,0,0,0,num1,text1,num2,1	Set I/O list entry 2 Entry = 2 (2) Service = SMS (2) Retry = NO (0) Timeout = 0 Priority = 0 Data 1 = SMS receiver number (<i>num1</i>) Data 2 = SMS text (<i>text1</i>) Data 3 = Service center Address (<i>num2</i>) Data 4 = SMS protocol UDP (1)
AT*WIOl=3,2,0,0,0,num3,text2,num4,1	Set I/O list entry 3 Entry = 2 (2) Service = SMS (2) Retry = NO (0) Timeout = 0 Priority = 0 Data 1 = SMS receiver number (<i>num3</i>) Data 2 = SMS text (<i>text2</i>) Data 3 = Service center Address (<i>num4</i>) Data 4 = SMS protocol UDP (1)

Send message

I/O input pulsed with two pulses 	SMS message <i>text1</i> transferred to receiver <i>num1</i>
I/O input pulsed with three pulses 	SMS message <i>text2</i> transferred to receiver <i>num3</i>

Testing by simulating the event

AT*WIOt=2	Force sending of SMS-message at entry 2
AT*WIOt=3	Force sending of SMS-message at entry 3

⌘ IDW-90 two wire half duplex

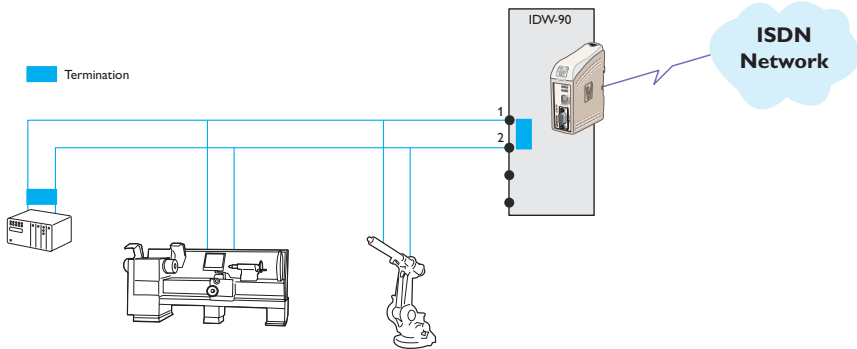

In this application the IDW-90 is set to communicate with a number of units with RS-485 interface. The communication is 2 wire half duplex at 38 400 bit/s, 8 data, parity even and 1 stop bit.

Configure the IDW-90

at**defa=0at**defa=1	Set the unit to factory default
AT&W	Store default settings
S2:6 ON	RS-422/485 enable RS-232 disable
S2:7 OFF	Select 2-wire RS-485
S1:4 ON	38.4 kbit/s
S1:7 ON	8data bits even parity 1 stop bit

To make switch setting active the power must be cycled OFF -> ON.



Westermo • SE-640 40 Stora Sundby, Sweden
Tel +46 16 42 80 00 Fax +46 16 42 80 01
E-mail: info@westermo.com
www.westermo.com